

Eco-Rail Power supply 1-phase, primary switched IN: 90-264VAC OUT: 24V/2,5ADC

INPUT: 90...264 V AC

OUTPUT: 24 V DC

Current: 2.5 A

Image

- stable output voltage, short-circuit and overload protected
- Wide voltage input
- touch protected (EN 60529) IP20

Vicarious picture

Approvals**Input**

Input voltage	90...264 V AC
Input current	1.1 A (115 V AC); 0.6 A (230 V AC)
Inrush current after 1 ms	<= 20 A
Primary fusing	max. 20 A
Frequency	50/60 Hz

Output

Output voltage	24 V DC (SELV), $\pm 1\%$
Output current	2.5 A (+40 °C); 2.0 A (+55 °C) 85 % (115 V AC); 87 % (230 V AC)
Mains failure bridging	>= 20 ms (115 V AC); >= 100 ms (230 V AC)
Ripple	<= 20 mV rms
Spikes	<= 100 mV p-p
Protection	Short-circuit and overload protected
LED display	LED (green) for output voltage
Parallel usage/serial usage	no/yes (max. 2 units)

General data

Standards	(EN 60950-1), (EN 61204-3), (EN 55022 B), (EN 61000-3-2)
Mounting method	DIN-rail mountable TH35 (EN 60715)
Relative humidity	20...90 %, no condensation
Temperature range	0...+40 °C, to +55 °C derating (storage temperature -20...+85 °C)
Dimensions H x W x D	125 x 50 x 80 mm

Commercial data

Net weight	490
Net weight	490
Weight unit	gram
Basic unit	pc.
Customs tariff number	85044090
Unit (piece)	1
Limited value	1

Comments

This switch mode power supplies meet the (EN 61000-3-2) standard for harmonic current.

All data on this data sheet was compiled carefully.

Liability regarding correctness, completeness, and actuality is limited to gross negligence. Created: 06/12

Circuit diagram

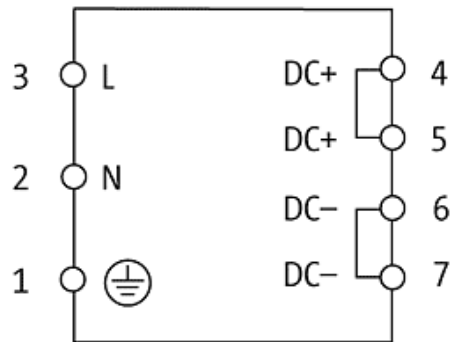

Dimension drawing

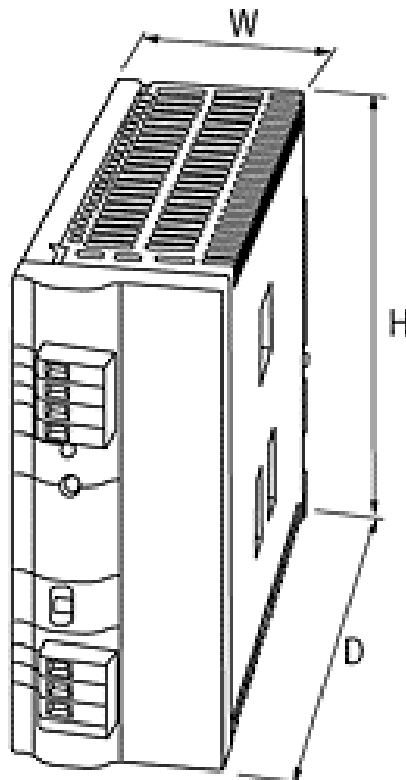

Representante oficial de:



[Argentina – Uruguay – Paraguay – Bolivia – Colombia – y Perú.]



Calle 49 N° 5764 - Villa Ballester (B1653AOX) - Prov. de Buenos Aires - ARGENTINA
Tel: (+54 11) 4768-4242 / Fax: (+54 11) 4849-1212
Mail: ventas@nakase.com.ar / Web: www.nakase.com.ar

