

MEF EMC-Filter 3-phase 2-stage I:8A U:3x500 VAC book-style

Current: 8 A

Image

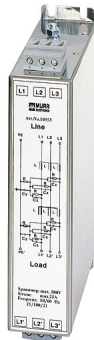

Vicarious picture

Technical Data

Operating voltage	max. 3 × 500 V AC
Operating frequency	50...60 Hz
Overload current	18 × IN t < 0.5 ms; 1.5 × IN t < 1 min. (1 × per hour)
Consumption at 250 V AC	max. 15 mA
Test voltage	L - N: 3.3 kV DC, 2 s; L - L: 3.1 kV DC, 2 s
Connection diameter	0.2...10 mm ² single core (AWG 24...7); 0.2...6 mm ² multiple core (AWG 24...9)

General data

Connection	Screw connection, touch protected
Climatic category	25/85/21 (EN 600068-1)
Mounting method	screw fixing, M6
Dimensions H × W × D	226 x 50 x 140 mm

Description

The 3-phase and one-stage EMC filters MEF 3/1 are used in the range 0.1...30 MHz and dampen interferences found in cables from the mains, supply units and control systems. They are suitable for TN-C- and IT mains. The best results are obtained with short connection cables (suggestion: earth connection < 10 cm) of the largest possible cross-section. The EMC filters are bi-directional. They reduce symmetrical and asymmetrical interferences that regularly appear with electronically controlled three phase units through mains influences.

Commercial data

Net weight	1700
Net weight	1700
Weight unit	gram
Basic unit	pc.
Customs tariff number	85363010
Unit (piece)	1
Limited value	1

Accessories

	Art.-No.
Grounding strip 16mm ² 200mm for M6 Tinned copper	4000-71001-1620006
Grounding strip 35mm ² 200mm for M6 Tinned copper	4000-71001-3520006

Comments

Attenuation curves on request.

All data on this data sheet was compiled carefully.

Liability regarding correctness, completeness, and actuality is limited to gross negligence. Created: 06/12

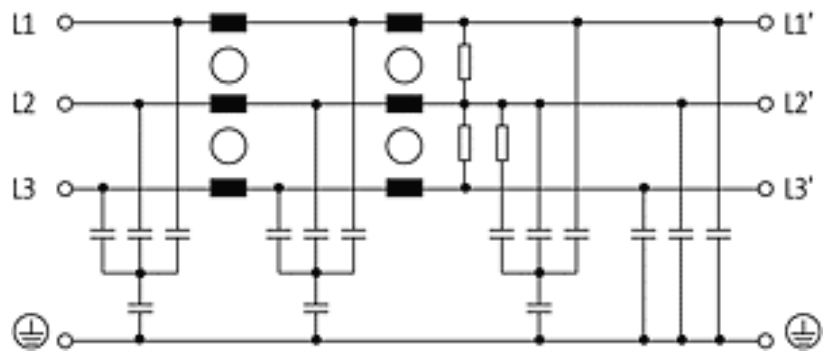
Circuit diagram

Representante oficial de:



[Argentina – Uruguay – Paraguay – Bolivia – Colombia – y Perú.]



Calle 49 N° 5764 - Villa Ballester (B1653AOX) - Prov. de Buenos Aires - ARGENTINA
Tel: (+54 11) 4768-4242 / Fax: (+54 11) 4849-1212
Mail: ventas@nakase.com.ar / Web: www.nakase.com.ar

