

**MEF EMC-Filter 3-phase 1-stage with neutral I:18A U:4x500 VAC**

Current: 18 A

**Image**

- with neutral

Vicarious picture

**Approvals****Technical Data**

Operating voltage	max. 3 × 500 V AC
Test voltage	L - N: 3.3 kV DC, 2 s; L - L: 3.1 kV DC, 2 s
Operating frequency	50...60 Hz
Consumption at 250 V AC	max. 15 mA
Overload current	18 × IN t < 0.5 ms; 1.5 × IN t < 1 min. (1 × per hour)
Connection diameter	0.2...10 mm <sup>2</sup> single core (AWG 24...7); 0.2...6 mm <sup>2</sup> multiple core (AWG 24...9)

**General data**

Climatic category	25/85/21 (EN 600068-1)
Mounting method	screw fixing, M6
Dimensions H × W × D	153 x 130 x 100 mm

**Description**

The 3-phase and one-stage EMC filters MEF 3/1 are used in the range 0.1...30 MHz and dampen interferences found in cables from the mains, supply units and control systems. They are suitable for TN-S, TN-C-S, and TT networks. The best results are obtained with short connection cables (suggestion: earth connection < 10 cm) of the largest possible cross-section. The EMC filters are bi-directional. They reduce symmetrical and asymmetrical interferences that regularly appear with electronically controlled three phase units through mains influences.

**Commercial data**

Net weight	1000
Net weight	1000
Weight unit	gram
Basic unit	pc.
Customs tariff number	85363030
Unit (piece)	1
Limited value	1

**Accessories**

	<b>Art.-No.</b>
Grounding strip 16mm <sup>2</sup> 200mm for M6 Tinned copper	4000-71001-1620006
Grounding strip 35mm <sup>2</sup> 200mm for M6 Tinned copper	4000-71001-3520006

**Comments**

Attenuation curves on request.

All data on this data sheet was compiled carefully.

Liability regarding correctness, completeness, and actuality is limited to gross negligence. Created: 06/12

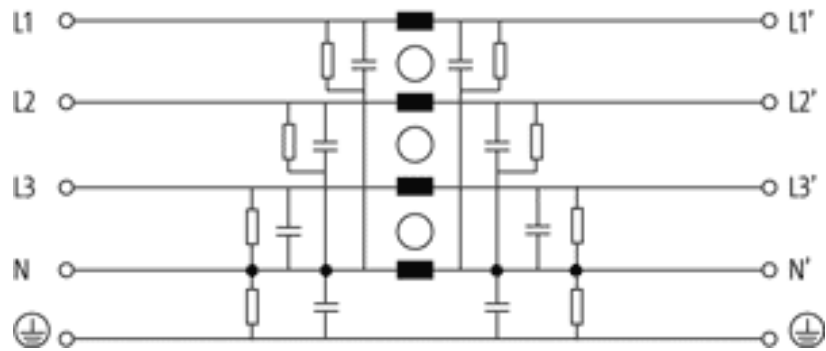
**Circuit diagram**

Representante oficial de:



[Argentina – Uruguay – Paraguay – Bolivia – Colombia – y Perú.]



Calle 49 N° 5764 - Villa Ballester (B1653AOX) - Prov. de Buenos Aires - ARGENTINA  
Tel: (+54 11) 4768-4242 / Fax: (+54 11) 4849-1212  
Mail: [ventas@nakase.com.ar](mailto:ventas@nakase.com.ar) / Web: [www.nakase.com.ar](http://www.nakase.com.ar)

