

Passive-distr. plastic, 4xM12, 4pol, pre-wired cable 15.0m PUR-IB 4x0,34+3x0,75

4-way, 4-pole
PUR/PVC
15.0 m
with LED for digital PNP-signals 24 V DC

Image



Vicarious picture

Approvals



Contact layout

Contact 1	(+)
Contact 2	(N/C)/(S2)
Contact 3	(-)
Contact 4	(N/O)/(S1)
Contact 5	(Earth)

Technical Data

Operating voltage	24 V DC
Operating voltage indicator	LED (green)
Signal per port	1
LED display per port	LED (yellow) per signal (PNP)
Operating current per contact (40 °C)	max. 4 A
Total current	max. 8 A
Housing	Plastic, flame retardant
Protection	IP65 and IP67 when plugged and screwed down (EN 60529)
Temperature range	-20...+80 °C

Technical data M12 port

Locking of ports	Screw thread M12 × 1 mm
------------------	-------------------------

All data on this data sheet was compiled carefully.

Liability regarding correctness, completeness, and actuality is limited to gross negligence. Created: 06/12

Cable		
No./diameter of wires	4 × 0.34 + 3 × 0.75 mm ²	
C-track properties	2 Mio.	
Jacket	PUR/PVC	
Outer diameter	approx. 7.4 mm	
Bend radius (mobile)	12 × outer diameter	
Cable number	333	
Commercial data		
Net weight	1495	
Net weight	1495	
Weight unit	gram	
Basic unit	pc.	
Customs tariff number	85444290	
Unit (piece)	1	
Limited value	1	
Accessories		
	M12 plastic lock screw	Art.-No. 58627
	DIN-rail adapter	27905
Comments		
	Further cable lengths on request.	

Contact layout

M12 Females 4-pole



Dimension drawing

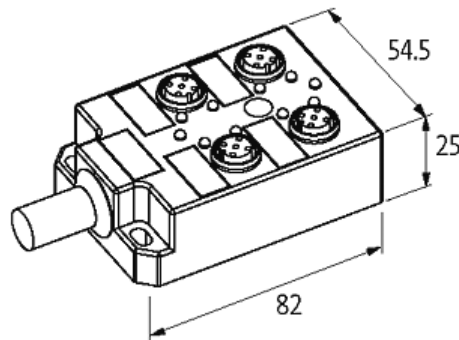

Representante oficial de:



[Argentina – Uruguay – Paraguay – Bolivia – Colombia – y Perú.]



Calle 49 N° 5764 - Villa Ballester (B1653AOX) - Prov. de Buenos Aires - ARGENTINA
Tel: (+54 11) 4768-4242 / Fax: (+54 11) 4849-1212
Mail: ventas@nakase.com.ar / Web: www.nakase.com.ar

