

T-coupler M12-male 4p./ 2x M8-female 3p. Replaced Art.-No. 3813880

T-coupler M12 ? M8

4-pole

Distribution function (N/O)

Image



Vicarious picture

Approvals



Form

41201

Technical Data

Operating voltage	max. 60 V AC/DC
Operating current per contact (40 °C)	max. 4 A
Protection	IP65 and IP67 when plugged and screwed down (EN 60529)
Temperature range	-25...+85 °C

Commercial data

Net weight	22
Net weight	22
Weight unit	gram
Basic unit	pc.
Customs tariff number	85369010
Unit (piece)	1
Limited value	1

Comments

Plastic housings with good resistance against chemicals and oils.

The resistance to aggressive media should be individually tested for your application. Further details on request.

All data on this data sheet was compiled carefully.

Liability regarding correctness, completeness, and actuality is limited to gross negligence. Created: 06/12

Contact layout

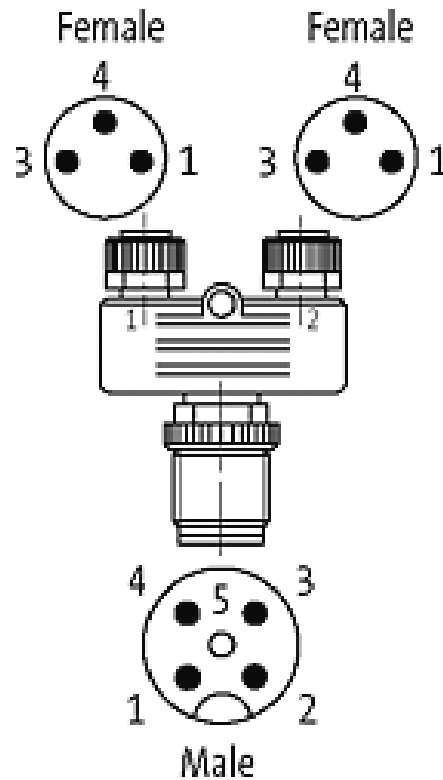

Circuit diagram

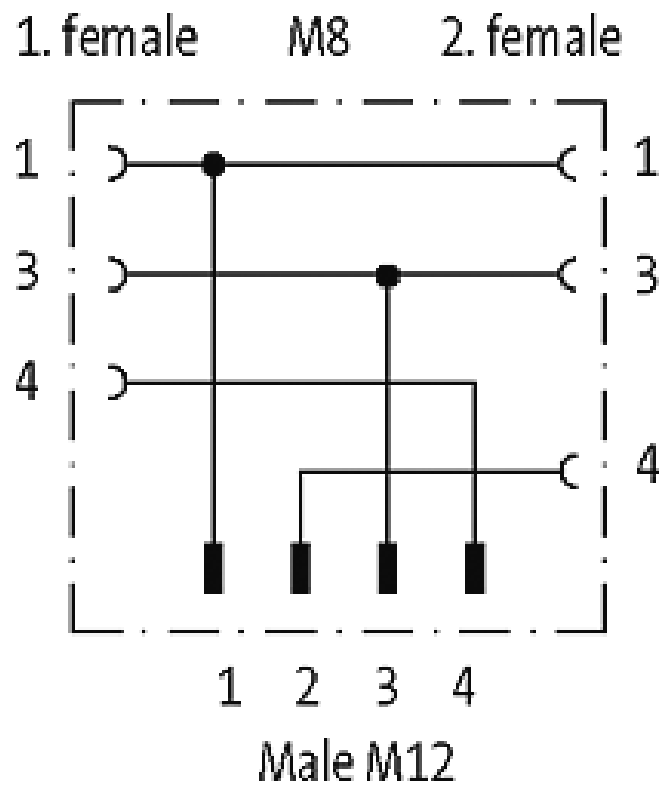

Dimension drawing

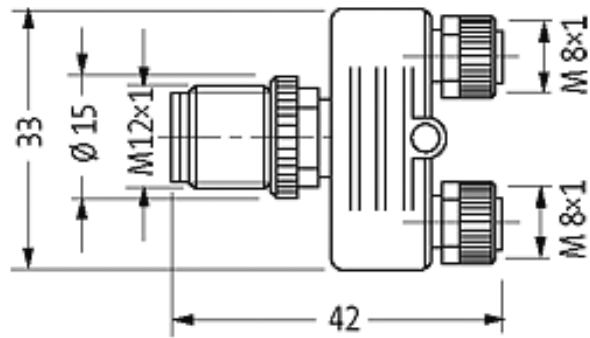

Representante oficial de:



[Argentina – Uruguay – Paraguay – Bolivia – Colombia – y Perú.]



Calle 49 N° 5764 - Villa Ballester (B1653AOX) - Prov. de Buenos Aires - ARGENTINA
Tel: (+54 11) 4768-4242 / Fax: (+54 11) 4849-1212
Mail: ventas@nakase.com.ar / Web: www.nakase.com.ar

