

MOSA MQ12 male straight field-wireable (IDC)

Male straight
3-pole
insulation displacement technology
Connection diameter: 0.25...0.5 mm²

Image

Vicarious picture

Approvals**Form**

12461

Technical Data

Operating voltage	max. 32 V AC/DC
Operating current per contact (40 °C)	max. 4 A
Connection diameter	0.25...0.5 mm ² (conductor diameter \geq 0.1 mm)
Clamping range (cable diameter)	4...5.1 mm
Wire isolation	PVC, PP, TPE
Outer wire diameter	1.2...1.6 mm
Protection	IP65 and IP67 when plugged and screwed down (EN 60529)
Temperature range	-25...+85 °C

Commercial data

Net weight	23
Net weight	23
Weight unit	gram
Basic unit	pc.
Customs tariff number	85369010
Unit (piece)	1
Limited value	1

All data on this data sheet was compiled carefully.

Liability regarding correctness, completeness, and actuality is limited to gross negligence. Created: 06/12

Contact layout

Male

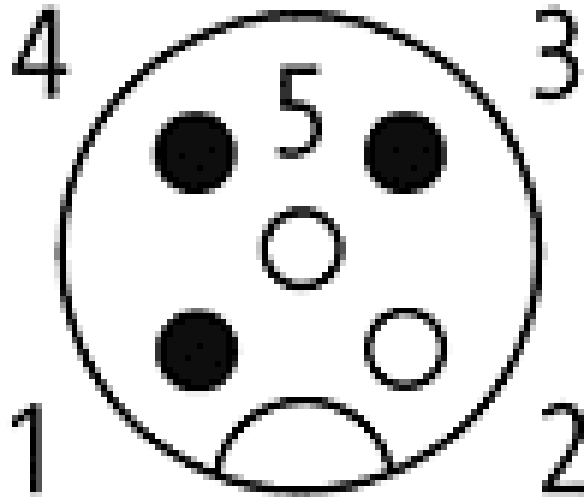

Circuit diagram

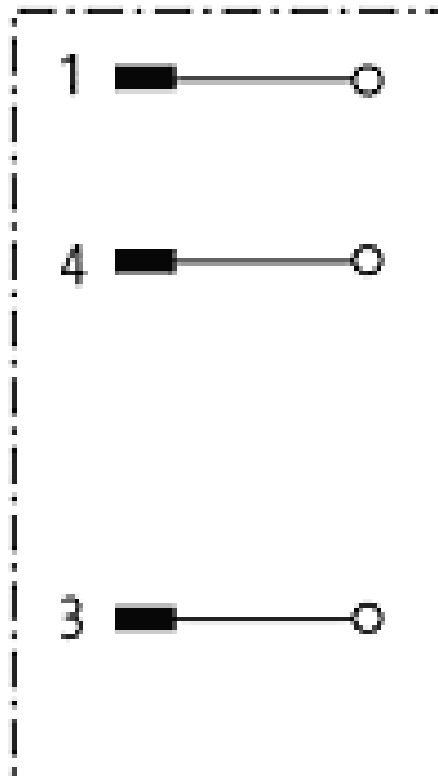

Dimension drawing

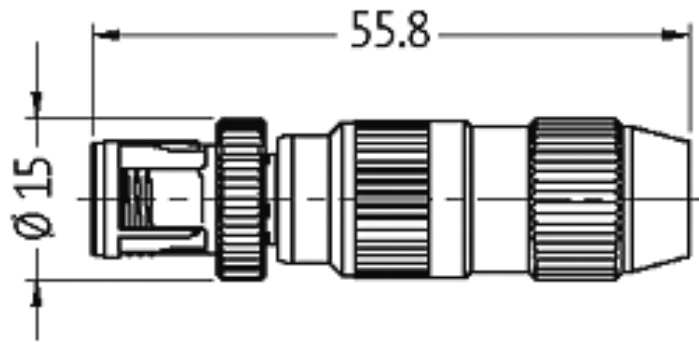

Representante oficial de:



[Argentina – Uruguay – Paraguay – Bolivia – Colombia – y Perú.]



Calle 49 N° 5764 - Villa Ballester (B1653AOX) - Prov. de Buenos Aires - ARGENTINA
Tel: (+54 11) 4768-4242 / Fax: (+54 11) 4849-1212
Mail: ventas@nakase.com.ar / Web: www.nakase.com.ar

