

**M12 female straight field-wireable Replaced Art.-No. 27620**

Female straight  
5-pole  
Clamping range cable entry: 4...6 mm

**Image**

Vicarious picture

**Approvals****Express shipments****Form**

12921

**Technical Data**

Operating voltage	max. 125 V AC/DC
Operating current per contact (40 °C)	max. 4 A
Connection diameter	max. 0.75 mm <sup>2</sup>
Clamping range (cable diameter)	4...6 mm
Protection	IP65 and IP67 when plugged and screwed down (EN 60529)
Temperature range	-25...+85 °C

**Commercial data**

Net weight	30
Net weight	30
Weight unit	gram
Basic unit	pc.
Customs tariff number	85369010
Unit (piece)	1
Limited value	1

**Comments**

Plastic housings with good resistance against chemicals and oils.  
The resistance to aggressive media should be individually tested for your application. Further details on request.

All data on this data sheet was compiled carefully.  
Liability regarding correctness, completeness, and actuality is limited to gross negligence. Created: 06/12

Contact layout

# Female

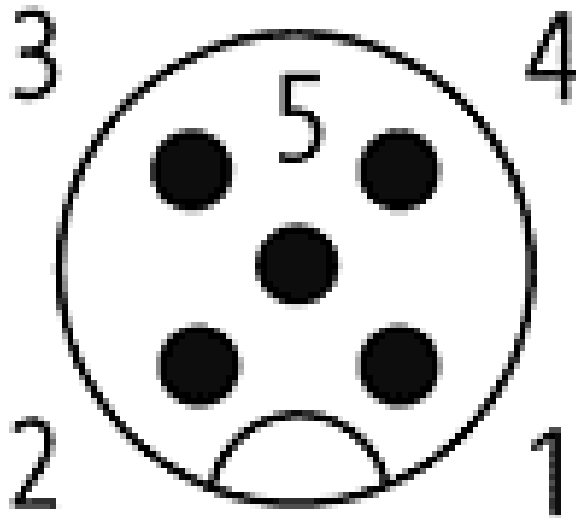

Circuit diagram

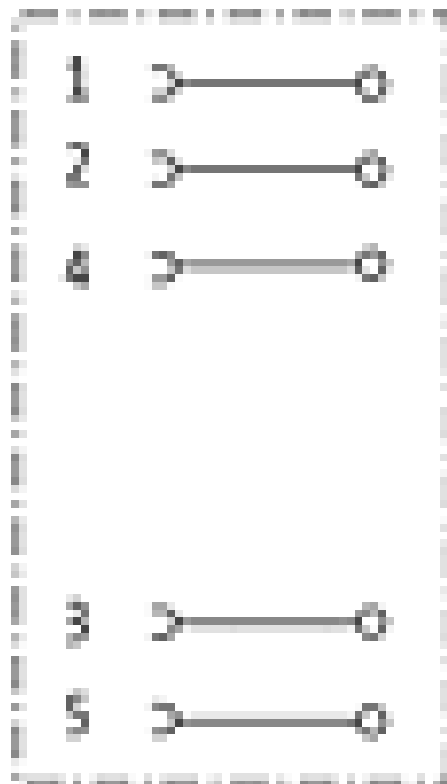

Dimension drawing

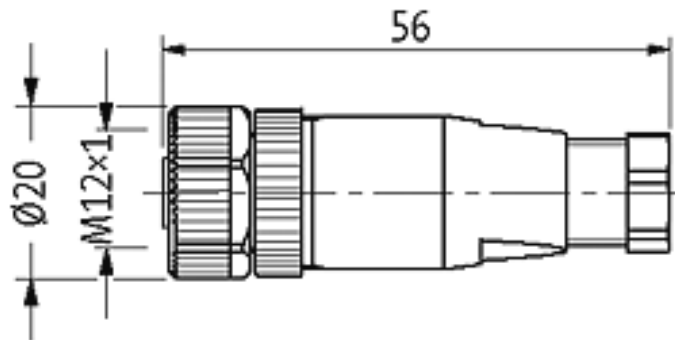

Representante oficial de:



[Argentina – Uruguay – Paraguay – Bolivia – Colombia – y Perú.]



Calle 49 N° 5764 - Villa Ballester (B1653AOX) - Prov. de Buenos Aires - ARGENTINA  
Tel: (+54 11) 4768-4242 / Fax: (+54 11) 4849-1212  
Mail: [ventas@nakase.com.ar](mailto:ventas@nakase.com.ar) / Web: [www.nakase.com.ar](http://www.nakase.com.ar)

