

**MOSA M12 male straight field-wireable (IDC)**

Male straight

3-pole

Connection diameter: 0.5...1.0 mm<sup>2</sup>

Art.-No. 7005 - M12 Lite - (plastic hexagonal screw) on request

**Image**

Vicarious picture

**Approvals****Express shipments****Form**

12511

**Technical Data**

Operating voltage	max. 32 V AC/DC
Operating current per contact (40 °C)	max. 4 A
Connection diameter	0.5...1.0 mm <sup>2</sup> (conductor diameter $\geq$ 0.1 mm)
Clamping range (cable diameter)	5.5...8 mm
Wire isolation	PVC, PP, TPE
Outer wire diameter	1.6...2.0 mm
Protection	IP65 and IP67 when plugged and screwed down (EN 60529)
Temperature range	-25...+85 °C

**Commercial data**

Net weight	20
Net weight	20
Weight unit	gram
Basic unit	pc.
Customs tariff number	85369010
Unit (piece)	1
Limited value	1

**Comments**

Plastic housings with good resistance against chemicals and oils.

The resistance to aggressive media should be individually tested for your application. Further details on request.

All data on this data sheet was compiled carefully.

Liability regarding correctness, completeness, and actuality is limited to gross negligence. Created: 06/12

Contact layout

# Male

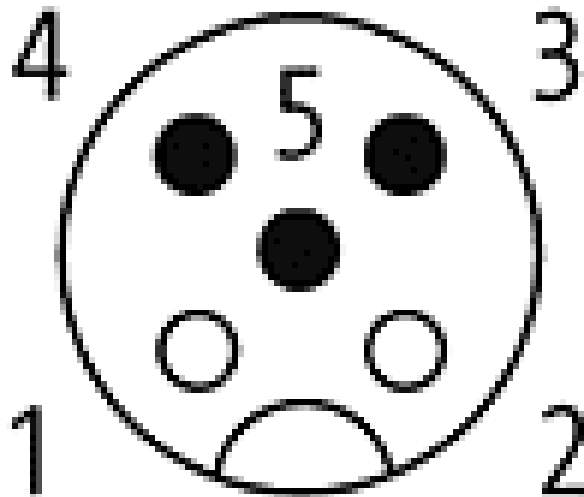

Circuit diagram

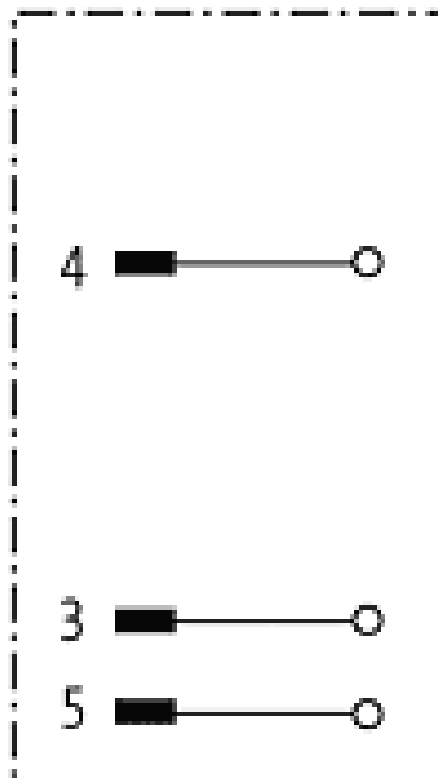

Dimension drawing

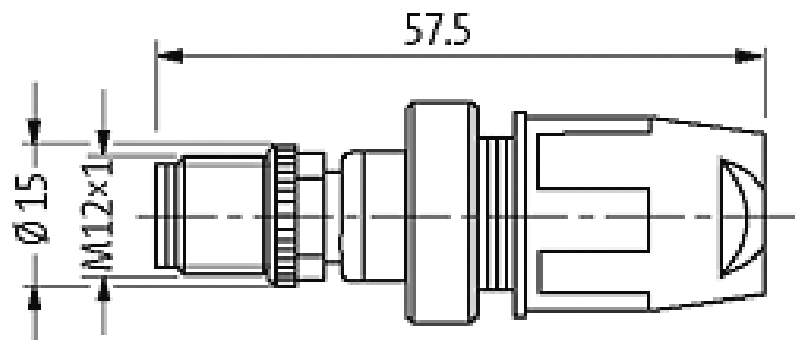

Representante oficial de:



[Argentina – Uruguay – Paraguay – Bolivia – Colombia – y Perú.]



Calle 49 N° 5764 - Villa Ballester (B1653AOX) - Prov. de Buenos Aires - ARGENTINA  
Tel: (+54 11) 4768-4242 / Fax: (+54 11) 4849-1212  
Mail: [ventas@nakase.com.ar](mailto:ventas@nakase.com.ar) / Web: [www.nakase.com.ar](http://www.nakase.com.ar)

