



» Aptos para sistemas de alimentación complejos formados por un gran número de componentes.



MICO detecta la falla y desconecta sólo el canal afectado.



» Ejemplo de conexionado:

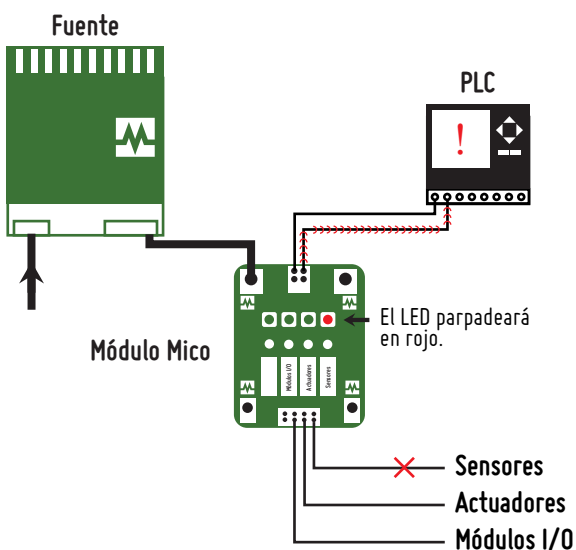

MICO funciona como un “Disyuntor inteligente” ya que reemplaza la utilización de interruptores maximizando el tiempo de identificación de fallas, ya que cuando se produce un cortocircuito o si se sobrepasa la carga de corriente el módulo MICO **desconecta sólo el canal afectado sin interferir en las fases que funcionan correctamente.**

APLICACIONES: Realización de armarios de control / Máquinas-herramienta / Packaging / Logística / Automatización / Alimentos y Bebidas.

MICO Electronic auxiliary circuit, 2 channels IN: 24VDC OUT: 24V/1-2-3-4ADC

MICO 2.4
2 channels
Current adjustment 1, 2, 3, 4 A

Image

- Fire protection (EN 60950-1)
- Operating voltage protection (EN 61131-2)
- Operating condition capacity (EN 61131-1)

Vicarious picture

Approvals**Technical Data**

Operating voltage	24 V DC (18...30 V DC)
Current adjustment	1 A, 2 A, 3 A, 4 A, by countersunk rotary switch, sealed
Inrush capacity	max. 20 mF (per channel)
Group alarm output	potential free alarm output 30 V AC/DC, 100 mA
Remote restart (ON)	10...30 V DC
Impulse length	min. 20 ms

General data

Connection	Spring clamp terminals
Input terminals	1 × 16 mm ²
Output terminals	per output 1 × 4 mm ²
Alarm terminals	2.5 mm ²
Bridging concept	one side, with spring clamp terminals or bridge set (max. 40 A)
Mounting method	DIN-rail mountable TH35 (EN 60715)
Temperature range	0...+55 °C (storage temperature -40...+80 °C)

Commercial data

Net weight	90
Weight unit	gram
Basic unit	pc.
Customs tariff number	85363010
Unit (piece)	1
Limited value	1

All data on this data sheet was compiled carefully.

Liability regarding correctness, completeness, and actuality is limited to gross negligence. Created: 04/13

Circuit diagram

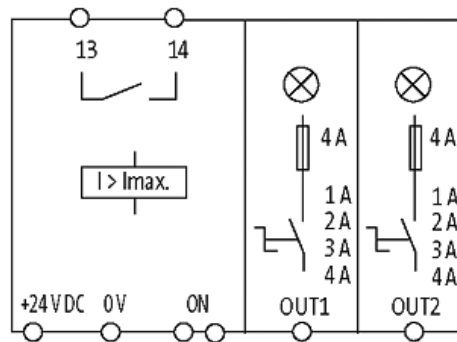

Dimension drawing

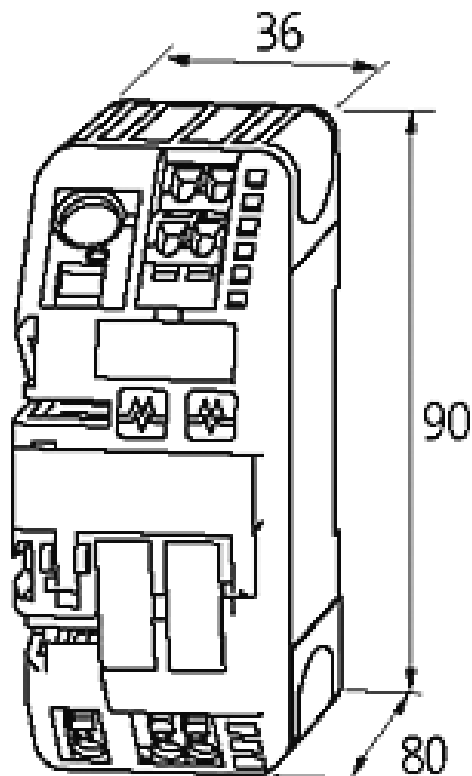

Representante oficial de:



[Argentina – Uruguay – Paraguay – Bolivia – Colombia – y Perú.]



Calle 49 N° 5764 - Villa Ballester (B1653AOX) - Prov. de Buenos Aires - ARGENTINA
Tel: (+54 11) 4768-4242 / Fax: (+54 11) 4849-1212
Mail: ventas@nakase.com.ar / Web: www.nakase.com.ar

